

Profil LED / Profile LED

# INSO

## Karta produktu Data sheet

**PL**

Profil wpuszczany – do oświetlenia pomieszczeń biurowych, sklepowych, domowych – oświetlenie architektoniczne – sufitowe, ściennie.

**EN**

Groove mounted profile – for lighting in offices, stores and homes – architectural lighting – ceiling- and wall-mounted.

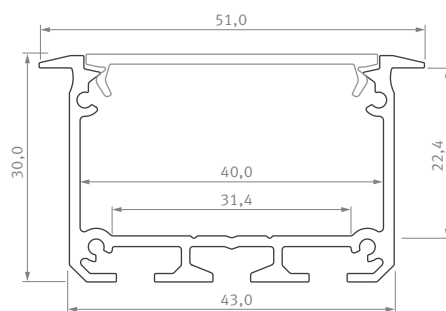

**Sposoby montażu /**  
Assembly methods



**Obejrzyj wideo /**  
Watch video



# INSO

## Profil LED / Profile LED

Wymiary [mm] / Dimensions (mm): 1000, 2020, 3000

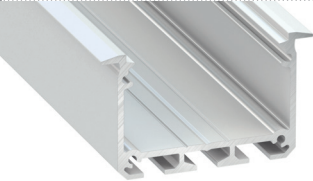
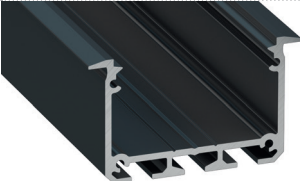
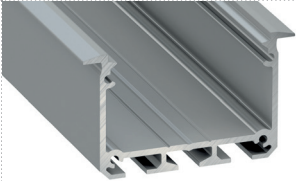



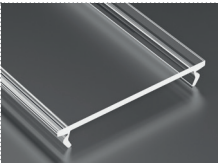
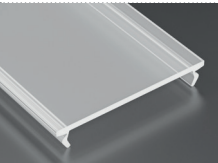
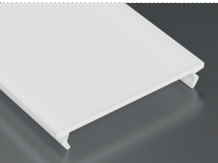
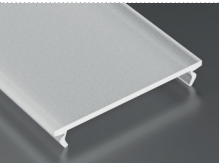
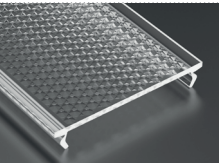
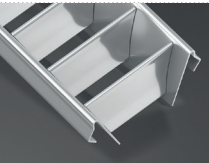

	<b>BIAŁY (lakierowany)</b> white (lacquered)	<b>CZARNY (lakierowany)</b> black (lacquered)	<b>SREBRNY (anodowany)</b> silver (anodized)
<b>Kolory profili</b> Profile colors			
1,0 m	10-0121-10	10-0125-10	10-0124-10
2,02 m	10-0121-20	10-0125-20	10-0124-20
3,0 m	10-0121-30	10-0125-30	10-0124-30
<b>Szerokość taśmy LED (mm)</b> LED strip width (mm)	<b>3 × 10</b>		

## Klosze (PVC/PMMA/PC) / Covers







Wymiary [mm] / Dimensions (mm): 1000, 2020, 3000

<b>TRANSPARENTNY</b> transparent	<b>MROŻONY</b> frozen	<b>MLECZNY</b> milky	<b>FROSTED MLECZNY</b> milky frosted	<b>TRANSPARENTNY</b> transparent	<b>SREBRNY</b> silver
<b>WIDE</b>			<b>PRISMATIC PC</b>		
					
1 m/PMMA 11-2033-10 1 m/PC 11-3033-10	1 m/PMMA 11-2032-10 1 m/PC 11-3032-10	1 m/PMMA 11-2031-10 1 m/PC 11-3031-10	1 m/PMMA 11-2036-10	1 m/PC 11-3034-10	1m/ 14-7068-00

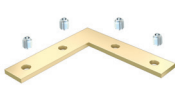
## Zaślepki (aluminium i tworzywo sztuczne) / End caps (aluminum and plastic)

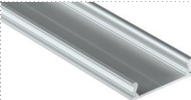
<b>Z OTWOREM</b> with a hole			<b>BEZ OTWORU</b> without a hole		
<b>BIAŁY</b> white	<b>CZARNY</b> black	<b>SREBRNY / SZARY</b> silver / gray	<b>BIAŁY</b> white	<b>CZARNY</b> black	<b>SREBRNY</b> silver
					
ALU 12-0000-12	ALU 12-0000-78	ALU 12-0000-13	ALU 12-0121-11	ALU 12-0122-11	ALU 12-0125-11
					
			ABS 12-0121-01		ABS lacq. 12-0125-01 ABS 12-0124-01

## Dodatki / Accessories

<b>ŁĄCZNIK PROSTY</b> straight connector	<b>ŁĄCZNIK KĄTOWY 90°</b> angular connector 90°	<b>ŁĄCZNIK POPRZECZNY KĄTOWY</b> angular transverse connector	<b>ŁĄCZNIK KĄTOWY 120°</b> angular connector 120°
			
14-3032-02	14-3030-01	14-3038-01	14-3036-01
<b>PROFIL MONTAŻOWY MODI</b> mounting profile MODI			<b>SPRĘŻYNY MONTAŻOWE</b> mounting springs
			
*S 1 m/10-0134-10	*W 10-0131-10	*B 10-0135-10	14-5001-00

\* S SREBRNY silver; \* B CZARNY black; \* W BIAŁY white

**Maksymalna rozpraszana moc źródeł światła LED**

Maximum dissipated power of LED light sources

dla temperatury profilu for temperature profile <b>55° C</b>	dla temperatury profilu for temperature profile <b>65° C</b>
<b>61,5 W</b>	<b>84 W</b>

**LUMINES**<sup>®</sup>  
LIGHTING

[www.lumines.pl](http://www.lumines.pl)

